

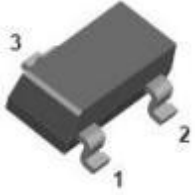

Features

- Planar Die Construction
- 300mW Power Dissipation
- Zener Voltages from 2.4V - 43V
- Ultra-Small Surface Mount Package Power Dissipation



- 1 . BASE
- 2 . EMITTER
- 3 . COLLECTOR

SOT-23

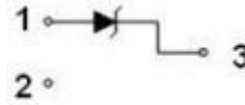
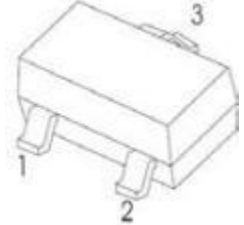

MAXIMUM RATINGS @ Ta=25°C unless otherwise specified

| Characteristic | Symbol | Value | Unit |
|--|-----------------------------------|----------|------|
| Forward Voltage (Note 2) @ IF = 10mA | V _F | 0.9 | V |
| Power Dissipation(Note 1) | P _d | 300 | mW |
| Thermal Resistance from Junction to Ambient | R _{θJA} | 417 | °C/W |
| Operation Junction and Storage Temperature Range | T _J , T _{stg} | -55~+150 | °C |



ELECTRICAL CHARACTERISTICS @ $T_a=25^{\circ}\text{C}$ unless otherwise specified

| Type Number | Code | Zener Voltage Range (Note 2) | | | | Maximum Zener Impedance (Note 3) | | | Maximum Reverse Current | | Temperature Coefficient of Zener voltage @ $I_{ZT}=5\text{mA}$ | |
|-------------|------|------------------------------|--------|--------|----------|----------------------------------|-------------------|----------|-------------------------|-------|--|------|
| | | $V_Z @ I_{ZT}$ | | | I_{ZT} | $Z_{ZT} @ I_{ZT}$ | $Z_{ZK} @ I_{ZK}$ | I_{ZK} | I_R | V_R | mV/ $^{\circ}\text{C}$ | |
| | | Nom(V) | Min(V) | Max(V) | (mA) | (Ω) | | (mA) | (pA) | (V) | Min | Max |
| BZX84C2V4 | Z11 | 2.4 | 2.20 | 2.60 | 5 | 100 | 600 | 1.0 | 50 | 1.0 | -3.5 | 0 |
| BZX84C2V7 | Z12 | 2.7 | 2.5 | 2.9 | 5 | 100 | 600 | 1.0 | 20 | 1.0 | -3.5 | 0 |
| BZX84C3V0 | Z13 | 3.0 | 2.8 | 3.2 | 5 | 95 | 600 | 1.0 | 10 | 1.0 | -3.5 | 0 |
| BZX84C3V3 | Z14 | 3.3 | 3.1 | 3.5 | 5 | 95 | 600 | 1.0 | 5 | 1.0 | -3.5 | 0 |
| BZX84C3V6 | Z15 | 3.6 | 3.4 | 3.8 | 5 | 90 | 600 | 1.0 | 5 | 1.0 | -3.5 | 0 |
| BZX84C3V9 | Z16 | 3.9 | 3.7 | 4.1 | 5 | 90 | 600 | 1.0 | 3 | 1.0 | -3.5 | 0 |
| BZX84C4V3 | Z17 | 4.3 | 4.0 | 4.6 | 5 | 90 | 600 | 1.0 | 3 | 1.0 | -3.5 | 0 |
| BZX84C4V7 | Z1 | 4.7 | 4.4 | 5.0 | 5 | 80 | 500 | 1.0 | 3 | 2.0 | -3.5 | 0.2 |
| BZX84C5V1 | Z2 | 5.1 | 4.8 | 5.4 | 5 | 60 | 480 | 1.0 | 2 | 2.0 | -2.7 | 1.2 |
| BZX84C5V6 | Z3 | 5.6 | 5.2 | 6.0 | 5 | 40 | 400 | 1.0 | 1 | 2.0 | -2.0 | 2.5 |
| BZX84C6V2 | Z4 | 6.2 | 5.8 | 6.6 | 5 | 10 | 150 | 1.0 | 3 | 4.0 | 0.4 | 3.7 |
| BZX84C6V8 | Z5 | 6.8 | 6.4 | 7.2 | 5 | 15 | 80 | 1.0 | 2 | 4.0 | 1.2 | 4.5 |
| BZX84C7V5 | Z6 | 7.5 | 7.0 | 7.9 | 5 | 15 | 80 | 1.0 | 1 | 5.0 | 2.5 | 5.3 |
| BZX84C8V2 | Z7 | 8.2 | 7.7 | 8.7 | 5 | 15 | 80 | 1.0 | 0.7 | 5.0 | 3.2 | 6.2 |
| BZX84C9V1 | Z8 | 9.1 | 8.5 | 9.6 | 5 | 15 | 100 | 1.0 | 0.5 | 6.0 | 3.8 | 7.0 |
| BZX84C10 | Z9 | 10 | 9.4 | 10.6 | 5 | 20 | 150 | 1.0 | 0.2 | 7.0 | 4.5 | 8.0 |
| BZX84C11 | Y1 | 11 | 10.4 | 11.6 | 5 | 20 | 150 | 1.0 | 0.1 | 8.0 | 5.4 | 9.0 |
| BZX84C12 | Y2 | 12 | 11.4 | 12.7 | 5 | 25 | 150 | 1.0 | 0.1 | 8.0 | 6.0 | 10.0 |
| BZX84C13 | Y3 | 13 | 12.4 | 14.1 | 5 | 30 | 170 | 1.0 | 0.1 | 8.0 | 7.0 | 11.0 |
| BZX84C15 | Y4 | 15 | 13.8 | 15.6 | 5 | 30 | 200 | 1.0 | 0.1 | 10.5 | 9.2 | 13.0 |
| BZX84C16 | Y5 | 16 | 15.3 | 17.1 | 5 | 40 | 200 | 1.0 | 0.1 | 11.2 | 10.4 | 14.0 |
| BZX84C18 | Y6 | 18 | 16.8 | 19.1 | 5 | 45 | 225 | 1.0 | 0.1 | 12.6 | 12.4 | 16.0 |
| BZX84C20 | Y7 | 20 | 18.8 | 21.2 | 5 | 55 | 225 | 1.0 | 0.1 | 14.0 | 14.4 | 18.0 |
| BZX84C22 | Y8 | 22 | 20.8 | 23.3 | 5 | 55 | 250 | 1.0 | 0.1 | 15.4 | 16.4 | 20.0 |
| BZX84C24 | Y9 | 24 | 22.8 | 25.6 | 5 | 70 | 250 | 1.0 | 0.1 | 16.8 | 18.4 | 22.0 |
| BZX84C27 | Y10 | 27 | 25.1 | 28.9 | 2 | 80 | 300 | 0.5 | 0.1 | 18.9 | 21.4 | 25.3 |
| BZX84C30 | Y11 | 30 | 28.0 | 32.0 | 2 | 80 | 300 | 0.5 | 0.1 | 21.0 | 24.4 | 29.4 |
| BZX84C33 | Y12 | 33 | 31.0 | 35.0 | 2 | 80 | 325 | 0.5 | 0.1 | 23.1 | 27.4 | 33.4 |
| BZX84C36 | Y13 | 36 | 34.0 | 38.0 | 2 | 90 | 350 | 0.5 | 0.1 | 25.2 | 30.4 | 37.4 |
| BZX84C39 | Y14 | 39 | 37.0 | 41.0 | 2 | 130 | 350 | 0.5 | 0.1 | 27.3 | 33.4 | 41.2 |
| BZX84C43 | Y15 | 43 | 40.0 | 46.0 | 2 | 100 | 700 | 1 | 0.1 | 32 | 10 | 12 |

- Notes: 1. Valid provided that device terminals are kept at ambient temperature.
2. Tested with pulses, period=5ms,pulse width =300ps.
3. $f = 1\text{kHz}$.



TYPICAL CHARACTERISTICS

Zener Characteristics (V_z Up to 10 V)

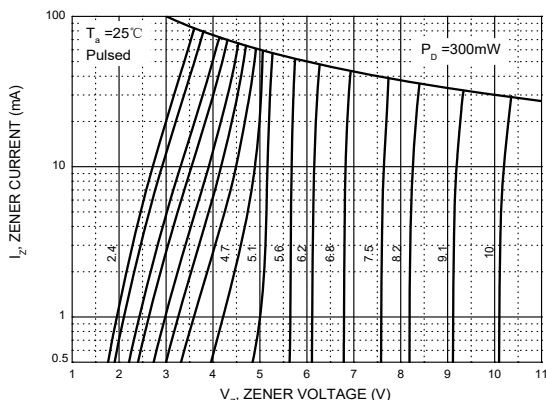

Zener Characteristics (11 V to 43 V)

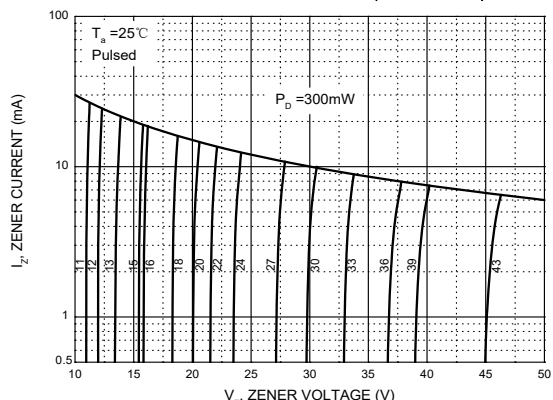

Temperature Coefficients

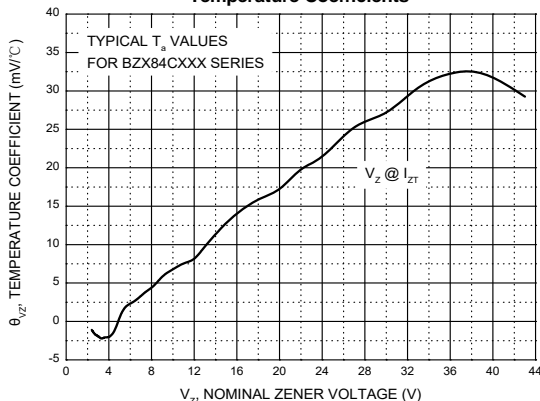

Typical Leakage Current

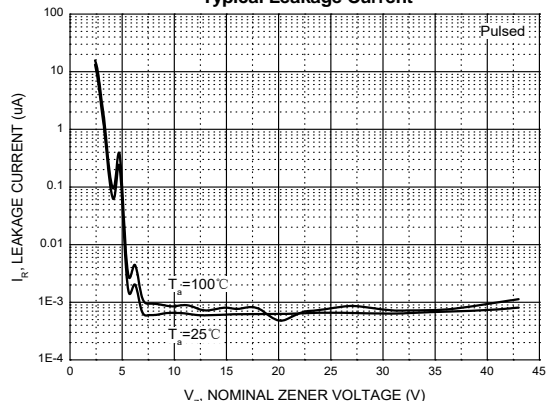

Typical Capacitance

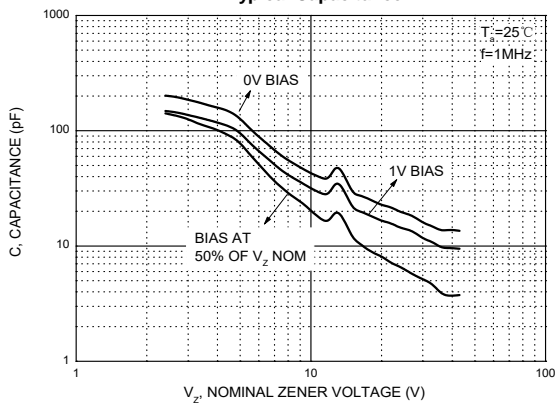

Effect of Zener Voltage on Zener Impedance

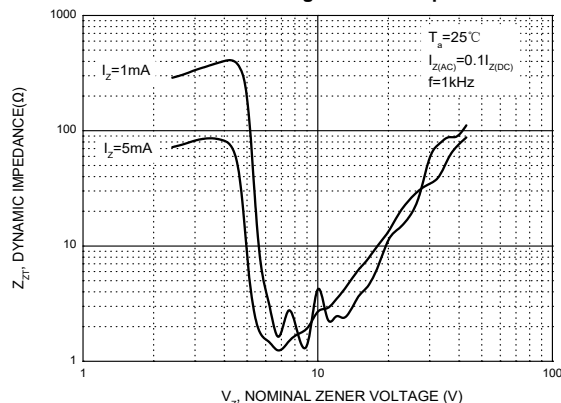

Power Derating Curve

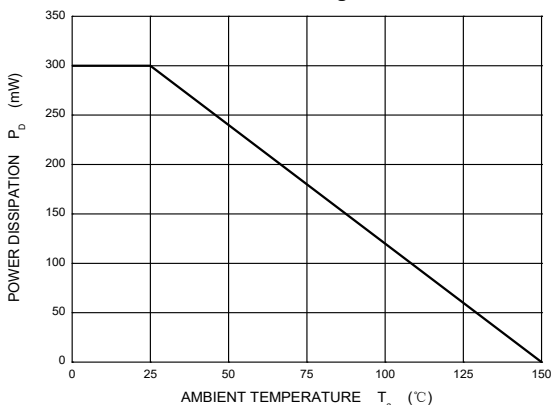

SOT-23 Package Outline Dimensions

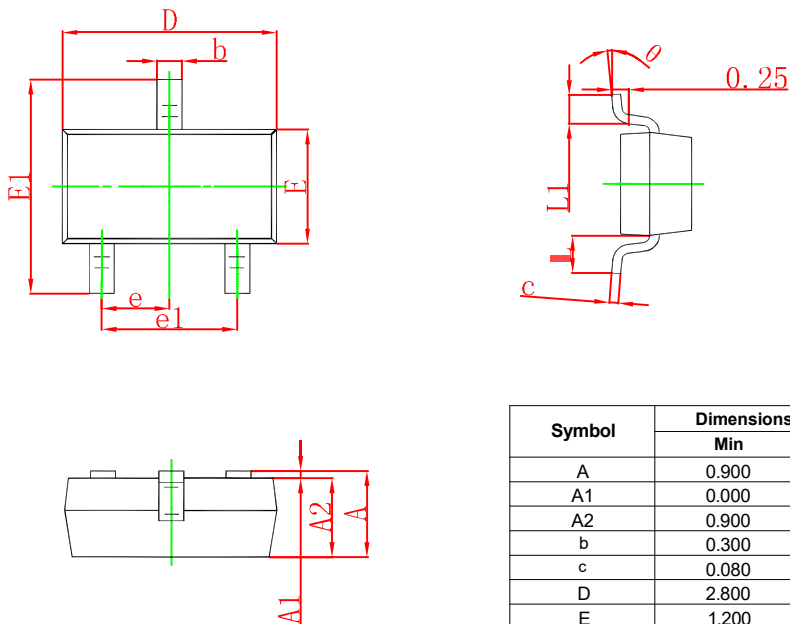

| Symbol | Dimensions In Millimeters | | Dimensions In Inches | |
|--------|---------------------------|-------|----------------------|-------|
| | Min | Max | Min | Max |
| A | 0.900 | 1.150 | 0.035 | 0.045 |
| A1 | 0.000 | 0.100 | 0.000 | 0.004 |
| A2 | 0.900 | 1.050 | 0.035 | 0.041 |
| b | 0.300 | 0.500 | 0.012 | 0.020 |
| c | 0.080 | 0.150 | 0.003 | 0.006 |
| D | 2.800 | 3.000 | 0.110 | 0.118 |
| E | 1.200 | 1.400 | 0.047 | 0.055 |
| E1 | 2.250 | 2.550 | 0.089 | 0.100 |
| e | 0.950 TYP | | 0.037 TYP | |
| e1 | 1.800 | 2.000 | 0.071 | 0.079 |
| L | 0.550 REF | | 0.022 REF | |
| L1 | 0.300 | 0.500 | 0.012 | 0.020 |
| θ | 0° | 8° | 0° | 8° |

SOT-23 Suggested Pad Layout

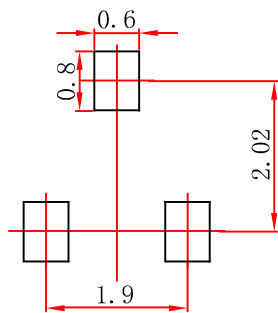

- Note:
1. Controlling dimension; In millimeters.
 2. General tolerance: ± 0.05mm.
 3. The pad layout is for reference purposes only.

SOT-23 Tape and Reel

SOT-23 Embossed Carrier Tape

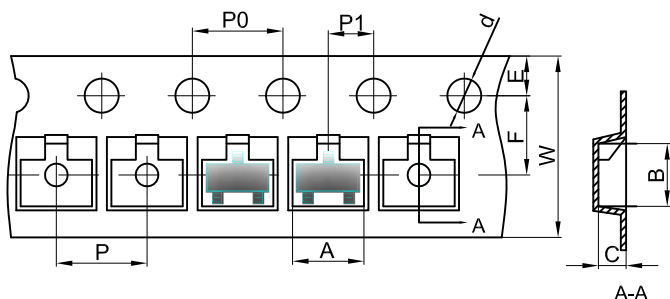

Packaging Description:

SOT-23 parts are shipped in tape. The carrier tape is made from a dissipative (carbon filled) polycarbonate resin. The cover tape is a multilayer film (Heat Activated Adhesive in nature) primarily composed of polyester film, adhesive layer, sealant, and anti-static sprayed agent. These reeled parts in standard option are shipped with 3,000 units per 7" or 17.8cm diameter reel. The reels are clear in color and is made of polystyrene plastic (anti-static coated).

| Dimensions are in millimeter | | | | | | | | | | |
|------------------------------|------|------|------|-------|------|------|------|------|------|------|
| Pkg type | A | B | C | d | E | F | P0 | P | P1 | W |
| SOT-23 | 3.15 | 2.77 | 1.22 | Ø1.50 | 1.75 | 3.50 | 4.00 | 4.00 | 2.00 | 8.00 |

SOT-23 Tape Leader and Trailer

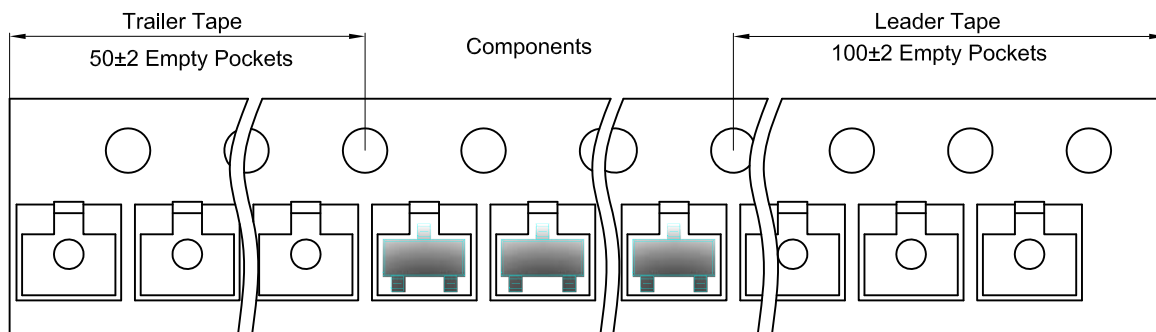

SOT-23 Reel

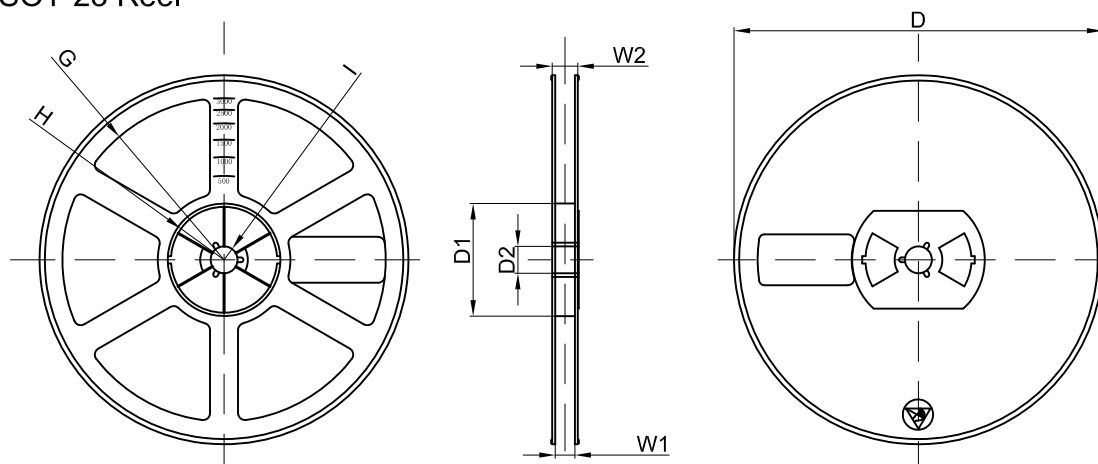

| Dimensions are in millimeter | | | | | | | | |
|------------------------------|---------|-------|-------|--------|--------|-------|------|-------|
| Reel Option | D | D1 | D2 | G | H | I | W1 | W2 |
| 7"Dia | Ø178.00 | 54.40 | 13.00 | R78.00 | R25.60 | R6.50 | 9.50 | 12.30 |

| REEL | Reel Size | Box | Box Size(mm) | Carton | Carton Size(mm) | G.W.(kg) |
|----------|-----------|------------|--------------|-------------|-----------------|----------|
| 3000 pcs | 7 inch | 45,000 pcs | 203×203×195 | 180,000 pcs | 438×438×220 | |